



# Supply Chain Dynamics, a Case Study on the Structural Causes of the Bullwhip Effect<sup>1</sup>

F. Villegas-Morán, O. Carranza y J.P. Antún

*Operations Management, Manchester Business School, University of Manchester, UK.  
Universidad Panamericana, México e Instituto de Ingeniería, UNAM*

*E- mails: fvillegas@man.mbs.ac.uk, ocarranz@mx.up.mx y jpantun@iingen.unam.mx*

(recibido: febrero de 2005; aceptado: junio de 2005)

## Resumen

Este artículo es un caso de estudio sobre el modelado de la estructura de toma de decisiones de la cadena de suministro de una embotelladora en México. Al modelar las cadenas de suministro de esta manera, es posible identificar las políticas gerenciales y los flujos de información que introducen y amplifican distorsiones en la demanda. En la segunda parte de este artículo, utilizamos dos escenarios para analizar posibles modificaciones en las políticas de dirección. Este trabajo ilustra no sólo una innovadora forma de estudiar el efecto látigo, o una forma distinta de modelar las cadenas de suministro usando los principios de dinámica de sistemas, sino que también establece una relación entre la estructura de información, las políticas de los gerentes y las distorsiones en la cadena de suministro.

**Descriptores:** Dinámica de sistemas, cadenas de suministro, caso de estudio, efecto látigo.

## Abstract

*This is a case study about the modeling of a supply chain decision structure of a Mexican bottling company. We find that by modeling the information and decision structure of supply chains, it is possible to identify managerial policies and information flows that distort and amplify market demand signals. In the second part of the paper we use two scenarios to analyze various changes in policies. This paper illustrates not only an innovative form to study the Bullwhip Effect nor only a different way to model supply chains using System Dynamics, but also it establishes a relationship between information structures, decision rules, and demand distortion in supply chains.*

**Keywords:** *System dynamics, supply chain management, case study, bullwhip effect.*

## Introduction

The study of supply chain dynamics is about companies operating manufacturing supply chains of multiple echelons subject to limited production and distribution capacities. At each echelon, operation managers receive orders from a downstream echelon and try to fulfill them by taking two decisions: shipping from available inventory, and ordering more products to the echelon upstream. Order policies are based on experience, opera-

tional strategy and information availability. Order fulfilment is constrained by production capacity, transportation capacity and inventory availability. Supply chain systems have mainly two time delays:

---

<sup>1</sup> Por razones de confidencialidad, los datos referidos en este artículo (a excepción de los públicos) han sido modificados. Por tanto, este modelo no refleja forzosamente la realidad del negocio en cuestión. Sin embargo, sentimos que esas modificaciones no afectan la validez científica de la investigación.

orders are communicated with information time delays, and they are fulfilled with operational time delays too (e.g., production and delivery). The supply chain dynamics problem consists in that given a set of order policies from managers at each echelon, market demand signals will be distorted and amplified (the Bullwhip Effect) through the echelons. The objective of supply chain dynamics problems is to minimize operational costs derived from those distortions and amplifications by improving managers order policies.

In the context of the supply chain dynamics problem, Forrester (1962), and Sterman (1989, 2000), have explored the impact of time delays. Lee *et al.* (1997a, 1997b) have explored the impact that batching, price discounts, rationing expectations and forecasting, have in the definition of order policies that lead to distortions of market demand signals. Towill *et al.* (1991, 1995), Naim *et al.* (2002) and Dejonckheere *et al.* (2002, 2003, 2004) have used an approach based on optimal control theory to find control policies to smooth the bull whip effect.

However, Forrester and Sterman's approaches fall short of study the supply chain dynamics because they use a predefined flow of information and management rules which are not longer valid for companies that use information systems. Towill *et al.* (1996, 2000), Dejonckheere *et al.* (2002, 2003, 2004) assume flow continuity for the supply chain

system in time, and that the supply chain policies can be always reduced to a set of partial differential equations that can be solved. As we know, this is not the case of real supply chains that are typically non-linear partial differential equations of higher order. Lee *et al.* (1997a, 1997b) did not suggest any new set of policies to improve the supply chains dynamics behaviour response.

PepsiCo has two divisions, Pepsi Cola North America, for the US, and PepsiCo Beverages International, for the rest of the world. In 2003, Pepsi-Cola North America (PCNA) had increments on volume (4%), revenue (18%) and operating profit (13%) as indicated in figure 1. PCNA grew faster than its largest competitor. In fact, PCNA gained share while Coca-Cola share declined. They are sure that innovation was the driver of that growth, because in fact PCNA brought an array of new products to the market place.

Much of that innovation focused on carbonated soft drinks (Figure 2). Pepsi Twist, which is Pepsi with a hint of lemon, helped the growth in their cola business. Within 30 days of launching Pepsi Twist in the US, Pepsi bottlers had sold more than 10 million cases. In addition, in its first full year on the market, lemon-lime Sierra Mist generated healthy sales and, where it was available, drove growth in the lemon-lime category. Meanwhile, Mountain Dew Code Red contributed to strong Mountain Dew growth of 6%.

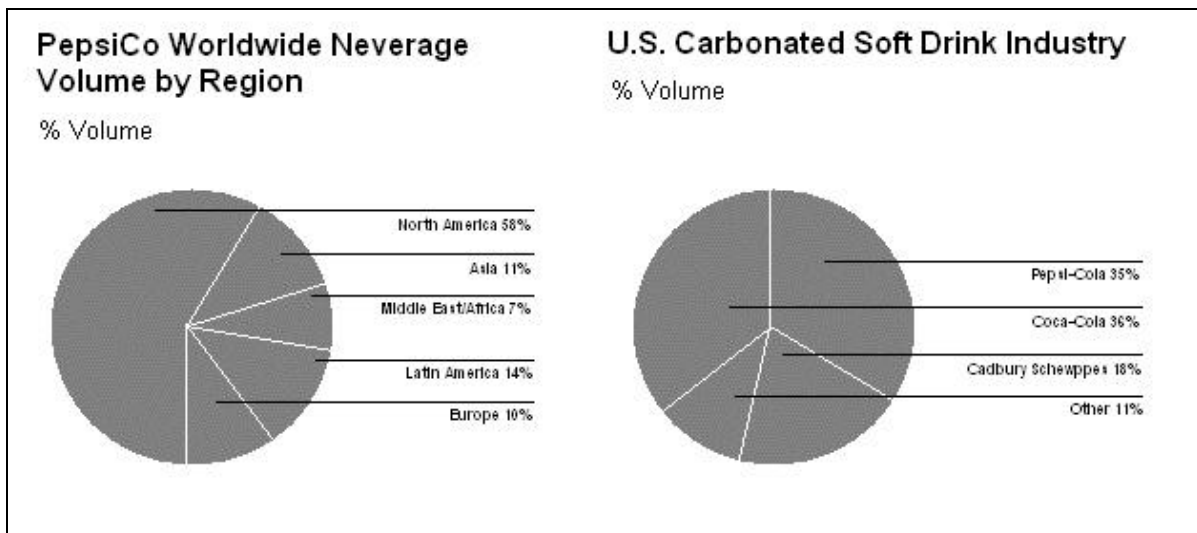

Figure 1: EMSA, PepsiCo worldwide beverage volume by region (Source: Annual report 2002)

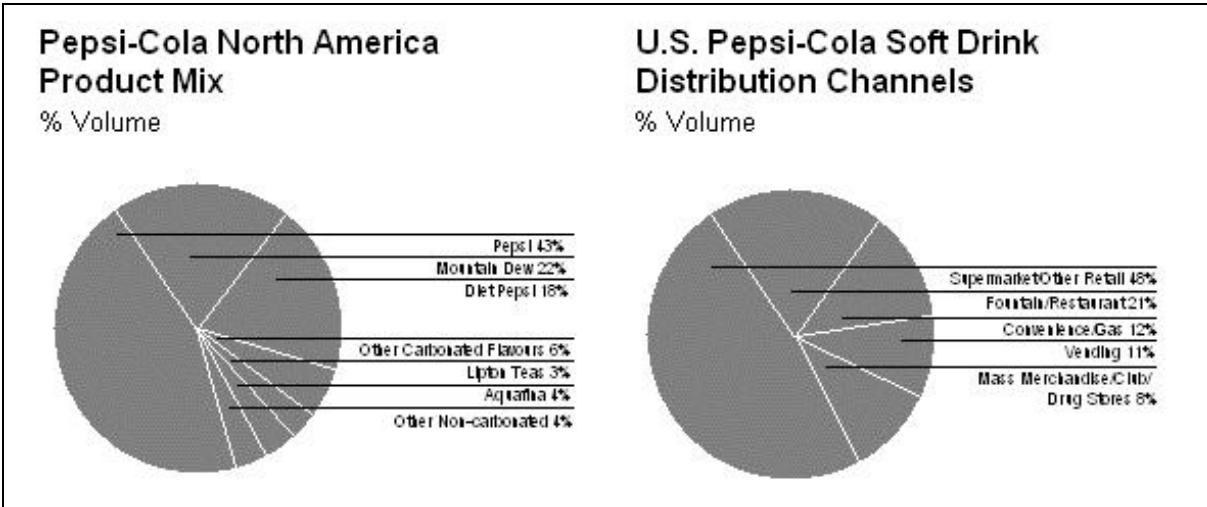

Figure 2: EMSA, Pepsi-Cola North America product mix and channels (Source: Annual report 2002)

While traditional carbonated soft drinks account for the bulk of beverage volume, as consumers seek greater variety, their non-carbonated drinks have been growing very rapidly, with volume up more than 30% in 2001. In fact, over the last decade they have built the leading portfolio of non-carbonated drinks (Figure 3) — including Aquafina bottled water, Lipton ready-to-drink teas, Frappuccino coffee drinks, Dole juices and drinks and SoBe beverages.

Aquafina is already the top-selling single-serve bottled water in the US. On the year of its introduction (2001), its volume grew about 45%. The launch of a new bottle helped PCNA growth of more than 20% in Lipton Iced Tea. And additional volume

growth came from products under the Dole and SoBe brands. PCNA's goal is to continue to improve its position in the market (Figure 4) to become the *fastest growing* broad-based beverage company. For this strategy it is central to keep the continuous expansion of its product portfolio.

PCNA, working with Frito-Lay North America (FLNA), also added excitement with awarded marketing campaigns in 27 urban centres across the U.S. They included merchandising, promotions and advertising that captured the attention of African-American and Latino consumers. PCNA and FLNA activated more than 5,500 accounts and achieved volume gains of more than 25% in participating stores.

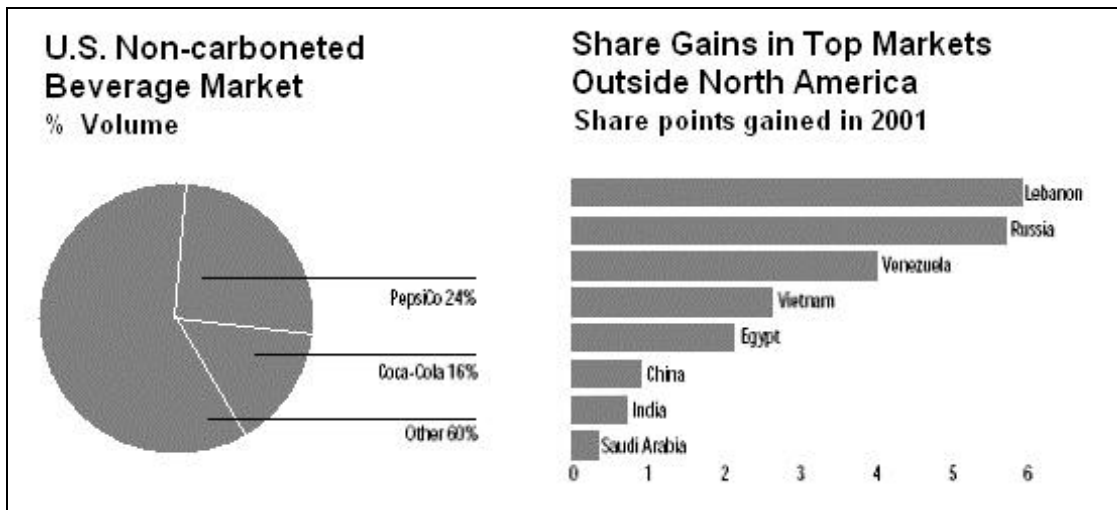

Figure 3. EMSA, U.S. Non-carbonated beverage market (Source: Annual report 2002)

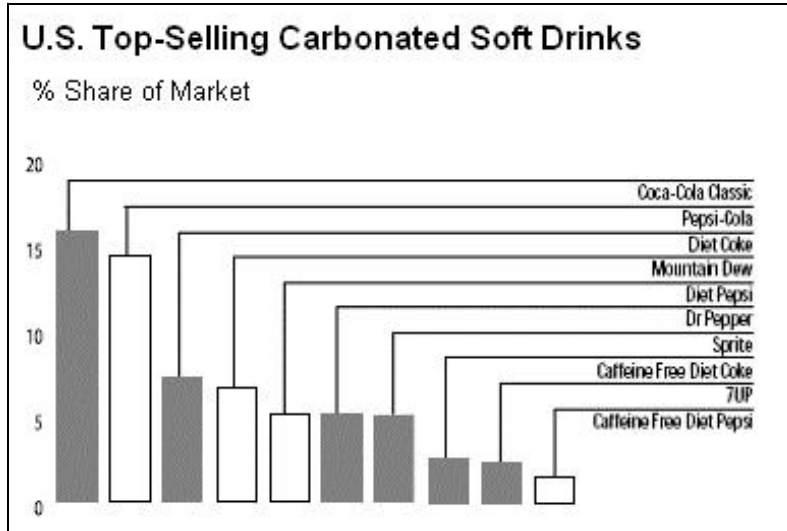

Figure 4: EMSA, U.S. Top-selling carbonated soft drinks (Source: Annual report 2002)

PepsiCo Beverages International (PBI), formed after the PepsiCo-Quaker merger by combining the international operations of Pepsi-Cola, Gatorade and Tropicana, posted a solid performance in its first

year. Volume was up nearly 5% (Table 1), matching their largest competitor. Revenue was up 2%. Operating profit was up 31%.

Table 1: EMSA, Pepsi-Cola North America operating profits (Source: Annual report 2002)

Pepsi-Cola North America				% Change B/(W)	
	2001	2000	1999	2001	2000
Net Sales					
Reported	\$3,842	\$3,289	\$2,605	17	26
Comparable	\$3,842	\$3,253	\$3,005	18	8
Operating profit					
Reported	\$927	\$833	\$751	11	11
Comparable	\$927	\$820	\$751	13	9
PepsiCo Beverages International				% Change B/(W)	
	2001	2000	1999	2001	2000
Net Sales					
Reported	\$2,582	\$2,531	\$2,407	2	5
Comparable	\$2,582	\$2,531	\$2,429	2	4
Operating profit	\$221	\$169	\$108	31	56

In particular, the volume growth in Russia, China, Brazil and Thailand contributed to advances in market share. In fact, PBI gained share in most of its top markets, with particular progress in Lebanon, Russia, Venezuela, Vietnam and Egypt.

Here too, innovation was a big factor. Extensions of the flagship Pepsi trademark helped to drive growth in a variety of local markets. For example, Pepsi Limón and Pepsi Twist — in both cases, Pepsi with a hint of lemon — proved also to be popular in dissimilar countries such as Mexico and Saudi Arabia. The launch of Mountain Dew contributed significantly to growth in Russia. And new additions to the established line-up of Mirinda brand flavours were launched in more than 30 markets.

During 2003, PBI gained important advantages by bringing together Pepsi-Cola, Gatorade and Tropicana. Combining the general and administrative functions of these businesses around the globe yields very substantial cost savings. In effect, the combination of Gatorade, Tropicana and Pepsi's water made a powerful portfolio for a wide range of needs — from simple refreshment to nutrition to post-exercise hydration — for consumers around the world.

## Modelling considerations

In our case study we work with the main bottler of PepsiCo Beverages International in Mexico: EMSA (Embotelladora Mexicana Sociedad Anónima), which attend Central Mexico, including the states of Jalisco and the Bajío. According with its supply chain manager, EMSA is considered the operational standard for the rest of Latin America. We selected a high sales volume product, in this case Pepsi 600ml which represent almost 40% of net sales.

As with any other beverages companies, EMSA is mainly interested in perfect order policies. That is, keeping inventories in all possible retailers, since product substitution against the competition is very frequent. In their business, product presence at sales point is translated into sales.

### *Purchase manager*

The main raw material for the production of Pepsi-Cola, apart of water of course, is sugar. They

purchase sugar based on price. Every year they select a small set of suppliers from a pool of possible vendors. Sugar price varies according to market. In Mexico most of the producers are state owned. There is a minimum amount of sugar to buy on a monthly basis of 185Ton. Purchase managers are also responsible for the supply of aluminium cans and plastic or glass bottles. Purchase managers generate a supply plan once every month and at least one month in advance. Pepsi uses its own fleet of trucks to pickup the materials from some suppliers. The following is an extract from the interviews with the purchase manager:

*"We have two main warehouses per plant: one for raw materials (sugar, labels, bottles and cans), and another for Pepsi syrup only. Right now we have US\$1.2m in inventories of raw materials. In this warehouse, there are components that are managed against schedule orders: labels, bottles and cans etc. We have a minimum stock inventory policy..."*

*We order based on a maximum and minimum with small corrections according to the real demand... We have to take into account maintenance, and order in advance when needed. We have also orders to be confirmed on a monthly basis. Every week we check our inventories and pay their invoices. 80% of our purchase is Pepsi syrup and sugar.*

*When a new product launch happens, we have to work closely with designers from PepsiCo Mexico. The designs are provided from the corporate headquarters, we then forward them to our label suppliers along with an initial purchase order..."*

*My main problems with Logistics are that they never give me the production programme!"*

### *Production manager*

When we interviewed the production manager, apart from being proud of their excellence awards in quality and achievements in reducing waste, he pointed out that one of the problems was the obsolescence of product due to shelf life. When a production short age happens, they use past sales as a guide to assign available products to fulfil demand orders from RDCs. This has generated in the sales managers the culture of over ordering when

rationing expectations appear. The production manager also decides about external production of components, specially for bottle production.

*"I am based very much on stock positions in the information system. Mainly, I look at inventory positions in warehouses or CEDIS (Centro de Distribución). I have my own policy of inventories. I always try to follow my policy, which is optimal. I look at the inventories once a week and from there I make a weekly plan: How much do I require for every product for the next week based on my forecast and stock position? How much is my excess or shortage?... then I decide if I need to produce many or a few.*

*Now, in [the case of] plastic and glass bottled products, because we never have high [expensive] inventories, I need to be very flexible in scheduling. But that is not the case of cans; [there] I try to make long production runs per week. In this way I can optimize the number of changes and set ups, for different flavours and sizes... [therefore] scrap is reduced... if I make many changes and setups, scrap is produced... [that is why] my intention is to make long runs each week".*

### Sales managers

They have all the market information in a system called SIME (Sistema de Información de Mercado), customer by customer. They have more than 150,000 sales points. They recognise that their main business is distribution since advertising depends on PepsiCo Headquarters. The average level of education reached by a salesman is secondary school. In principle, the forecast is produced by operational managers using econometric standards, and the sales managers are responsible of fine tune it with expected demand volumes per zone and by product. The sales managers do not follow the bottom up approach to create a forecast, because of previous experience, where demand was exaggerated by salesmen in an accumulative percentage of 80%, driven by the instinct to ensure product availability.

*"... About forecast... I believe that we never follow them... some time ago production used to supply us everything that we ordered, what the market needed and we sold, but later production asked for*

*a more precise forecast and they asked us to make a more precise prediction. We produced that forecast for 4 or 5 months directly, creating the forecast from our sales estimations based on the "last month sales" and we multiplied it by a factor month by month... together with past sales and new sale expectations we produced a forecast by space, brand, warehouse, flavours... we then sent that forecast to production... our accuracy was around 96% with some failures in flavours... some times boys [salesmen] required more orange than apple flavours and then again we had some complaints from production. We finally agree that forecasting was going to be again a responsibility of production, but under the assessment of the sales department... that they make it, but asking us and comparing against our own expectations... since then we have not followed this initiative properly... as I told you about forecasts, they know it very well, but up to now, we do not have well solved who is in charge of forecasts... they never call us to validate the forecast... that is what we have to improve!...*

*Everything goes together with sales... if we do not have the product we can not sell... the challenge of production is to produce all the necessary products (packages, labels) in order to send the products on time to reach warehouse early and then the salesman can take the product and deliver it to our customers as it should be: high quality, good image, good conditions of bottles, etc... I believe that production used to do a good job, same as sales... we have lots of things to improve."*

### Logistics manager

Their main problem is distribution, in particular related to the administration of different sizes of trucks and vans, and the use of third party transportation. The logistics managers do not have a clear vision about which RDCs can receive full size trucks, but they know that inter-plants can receive double-sized trucks. They are trying to use the in-house fleet as much as possible but without replacing them, due to a strategy to move from owned trucks to third party transportation. His performance is measured in relation with the transportation cost (per product unit), and the average capacity loaded per truck (% load/capacity).

## Model description

Given the nature of the System Dynamics methodology (Sterman 2002; Lane 2001; Doyle and Ford 1998), the model will not emphasise the detail of the Supply Chain network. SD models are abstractions that concentrate the attention not in a detailed modelling of the reality but in the cause-effect and feedback loops that generate a given behaviour. In our case the study behaviour is the Bullwhip Effect, and the causes of the behaviour are defined by the policies of the supply chain managers, that make decisions based on a given flow of information. Therefore, the model is limited in detail but not in meaning since our analysis of distortions is of an aggregated nature. Particularly, a model of this nature does not need to detail multiple plants or DCs and products to analyze the information use and decision making process of managers.

The model lays emphasis on the modelling of policies of the supply chain managers that may be based on their own experience or knowledge. We make explicit the use of information flows and their sources. The model shows the availability and reliability of the information through the information systems used by the business. The model can

also be used to analyze the congruency of decision makers with respect the information systems.

We have selected for model validation and calibration (parameterization) the historic demand for the year 2002. Based on this demand we have modelled the supply chain dynamics by including heuristic policies as described by the supply chain managers during our interviews. The model shows the main aggregated behaviour of inventories, differences between plan and execution and the resulting service level. The decision making happens at the beginning of every week, when managers look at the information systems and decide how much to order upstream. Every event with less than one week duration is considered as a simultaneous one for the purposes of the simulation. The time step unit is weeks and all order quantities are in finished goods equivalent units.

Figure 5 shows the model diagram for the Pepsi 600ml. Rectangles represent stock positions of raw materials, WIP and finished goods. As can be seen, in the model we have defined four stock positions in the model: raw material (RM), work in process (PLANT), finished goods at warehouses (DC) and finished goods in depots (RDC). The raw material

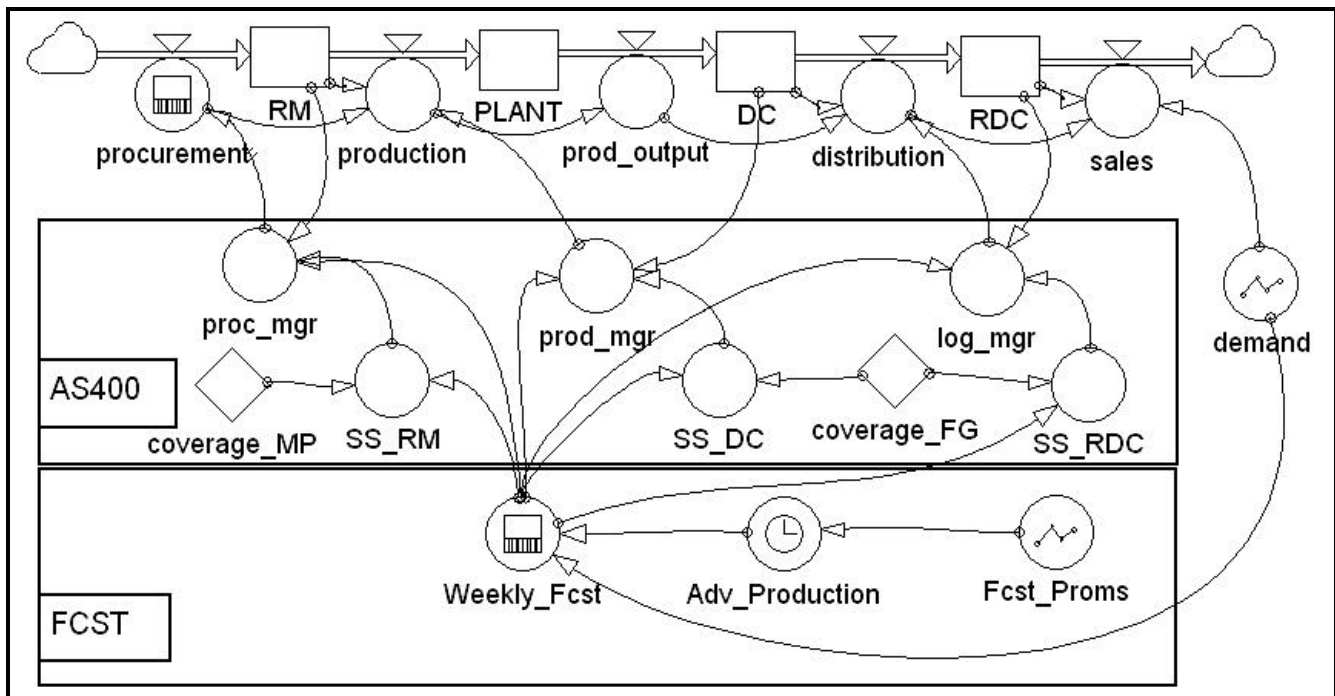

Figure 5: EMSA Supply chain model

stock units represent all the components needed to build one unit of finished goods.

Variables are represented with circles, and constants with diamonds. The variable value or constant is communicated to another variable by drawing a single arrow. Some variables represent decision makers (managers) and include the use of information inputs into a function that ends with a numerical decision (e.g., production order). Supply chain managers are represented by the variables *proc\_mgr*, *prod\_mgr*, and *log\_mgr*. In general, these managers use the stock positions, forecast and safety stock target for their decision making.

EMSA operational managers use the term "coverage" to define the safety stock policy defined in terms of forecasted days/weeks of demand. The safety stock policies, or safety stock target, are constant values. Coverage policies are different for raw materials and finished goods mainly because there is a delay of more than one week from purchase to delivery of materials.

Demand forecast is calculated using the last 3 weeks (PastTime) of historic demand and we use them to project the next FutureTime demand according to the FORECAST function extrapolation that uses exponential smoothing.

The model groups variables/parameters in two rectangles that represent the information system where the information is allocated. Pepsi-EMSA has an ERP system derived from IBM's AS400 and an informal forecast system based in Excel.

The model can include promotional events and the introduction of new products, in such a way that the forecast is not only influenced by past weeks but also by marketing campaigns. Also some special seasons where some production needs to be allocated in advance to avoid production overload. These ideas are captured by the variables *Fcst\_Proms* and *Adv\_Production*.

Given that our model is continuous, non-linear and fourth degree system, we used a numerical solution method for the analysis. The model is described in mathematical form as follows. First the state variables are defined by:

$$RM = \int_{t_0}^{t_1} (proc\_RM(t) - production(t)) dt$$

$$Factory = \int_{t_0}^{t_1} (production - prod\_output(t)) dt$$

$$DC = \int_{t_0}^{t_1} (prod\_output(t) - distribution(t)) dt$$

$$Retailers = \int_{t_0}^{t_1} (distribution(t) - sales(t)) dt$$

Rate variables are defined:

$$proc\_RM = DELAYPPL(Proc\_mgr, 10)$$

$$production = \begin{cases} RM + proc\_RM, & Prod\_mgr > RM + proc\_RM \\ Prod\_mgr, & Prod\_mgr \leq RM + proc\_RM \end{cases}$$

$$prod\_output = production$$

$$distribution = \begin{cases} DC + prod\_output, & Dist\_mgr > DC + prod\_output \\ Dist\_mgr, & Dist\_mgr \leq DC + prod\_output \end{cases}$$

$$sales = \begin{cases} Retailers + distribution, & Demand > Retailers + distribution \\ Demand, & Demand \leq Retailers + distribution \end{cases}$$

Auxiliary variables are:

$$Proc\_mgr = \begin{cases} SS\_RM + forecast\_2, & SS\_RM + forecast\_2 > RM \\ 0, & SS\_RM + forecast\_2 \leq RM \end{cases}$$

$$Prod\_mgr = \begin{cases} 0, & DC > forecast\_1 + SS\_DC \\ forecast\_1 + SS\_DC, & DC \leq forecast\_1 + SS\_DC \end{cases}$$

$$Dist\_mgr = \begin{cases} 0, & Retailers > forecast\_1 + SS\_Retailer \\ forecast\_1 + SS\_Retailer, & Retailers \leq forecast\_1 + SS\_Retailer \end{cases}$$

$$forecast\_1 = FORECAST(Demand, 3, 1)$$

$$forecast\_2 = FORECAST(Demand, 3, 2)$$

$$AdvancedProduction = \begin{cases} 1.025 * Fcst\_Promotions, & TIMES(9) \\ 0, & otherwise \end{cases}$$

$$SS\_DC = forecast\_1 * coverage\_PT$$

$$SS\_Retailer = forecast\_1 * coverage\_PT$$

$$SS\_RM = coverage\_m * forecast\_2$$

Initial values and parameters:

$$coverage\_RM = 0.5$$

$$coverage\_PT = 0.5$$

$$DC(t_0) = 20,000 \text{ units}$$

$$Factory(t_0) = 0 \text{ units}$$

$$Retailers(t_0) = 20,000 \text{ units}$$

$$RM(t_0) = 20,000 \text{ units}$$

The DELAYPPL function is an infinite Order Material Delay. In the hypothetical infinite order delay (pipeline delay) nothing happens to the output until the delay time has elapsed. At this time the



input variable is reproduced exactly. A pipeline delay may be looked upon as a “movingsidewalk” or conveyor belt, where items are put on the conveyor at one end, and expelled at the other end after a fixed time.

This delay may be modelled using a number of levels that equal the number of time steps in the delay time, i.e.,  $DelayTime/TIMESTEP$ . In each time step, material is moved from one level to the next, until it reaches the final level, where it is output. In Powersim this may be modelled using a vector level, and applying the SHIFTLIF function at each time step to shift elements from one position to the next.

Pipeline delay: Equations of an Infinite Order Material Delay if we assume there are ten steps in a delay time, the equations become:

```

aux Input = "Input rate to be delayed"
init InTransit = "Initial contents of delay"
dim InTransit = 1..10
flow InTransit(i) = dt*(Input | i=1;0) - dt*(Output |
    i=LAST(i);0)
aux Output = SHIFTLIF(TRUE, InTransit)
    
```

The function DELAYPPL is used to express this kind of delay, we can write directly:

```

aux Output = DELAYPPL(Input,
    DelayTime, 0)
    
```

Syntax: DELAYPPL (Input, DelayTime[, Initial=Input])

Input: Variable to be delayed (delayed parameter).

DelayTime: Delay time measured in the time unit of the simulation(start-upparameter).

Initial: Initial delay value (optional start-up parameter with default equal to Input).

Result: The value of Input at DelayTime time units earlier in the simulation. During the first DelayTime time units of the simulation, the values specified by Initial are returned (Initial is a vector with one element per time step for a period equal to DelayTime).

Diagram: The pipe-line delay, figure 6, may be modelled using a vector with Delay Time/TIMESTEP elements, which is shifted linearly to the right every time step:  
Equations

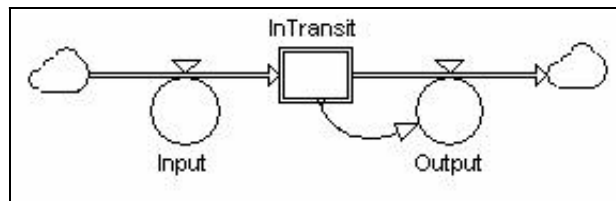

Figure 6. Delay Pipe-Line

```

aux Input = ...
init InTransit = ...
dim InTransit = 1..10
flow InTransit(i) = dt*(Input | i=1;0) - dt*(Output |
    i=LAST(i);0)
aux Output = SHIFTLIF
    
```

SHIFTLIF\_Conditional\_Linear\_Shift\_of\_Vector\_ Elements>func(TRUE, InTransit)

The number of elements of InTransit should be set equal to the number of time steps in a DelayTime period, i.e.,  $DelayTime/TIMESTEP$ .

### Validation

When a simulation is ran using historic demand from the year 2002, we can observe some dynamics resulting from the decision making structure used by the managers and in addition of uncertain demand.

Table 3. EMSA Finished goods inventory movements at RDCs

Week	RDC initial	Input orders	Sales
0	20000	0	13083
1	6917	17189	15392
2	8714	15105	15392
3	8427	19823	17701

con tin u ous...

Table 3. EMSA Finished goods inventory movements at RDCs(...continuation)

Week	RDC initial	Input orders	Sales
4	10549	8096	12884
5	5761	17224	15157
6	7849	15086	15157
7	7779	19545	17431
8	9893	15285	16501
9	8678	22162	19413
10	11427	18910	19413
11	10925	24978	22325
12	13578	15680	19314
13	9945	25939	22723
14	13161	22205	33723
15	12643	29248	26131
16	15760	32484	29574

In table 3 we can see the stock movement in the RDCs. The initial inventory is 20,000 units. During the first week we have no arrivals but sales of 13,083 units, resulting in a closing inventory of 6,917 units. However, during the first week the distribution manager orders finished goods from the DC upstream to return to the planned stock levels and cover expected future product demand. The shipment from DC to RDC happens during the week. Therefore, at the end of the week the RDC

restores its the planned stock levels. In effect, during the following week, new demand for 15,392 units is served and 17,189 units of stock are received, reaching a final inventory of 8,714 units.

Given the motive of this business, it is not possible to count on the supply of backorders either. If during a given week demand exceeds inventory on hand, the supplier manager only serves as much as possible, and does not consider the shortage for later.

It is important to see that during the initial moments of the simulation, we start from initial inventories (parameters), and after a few moments the model reaches a warm-up state that corresponds more to the evolution of the system than to the initial values. Therefore, we will consider only the behaviour of the system after the 10<sup>th</sup> week.

In figure 7 we show the customer service level. The dotted line represents the forecast value and in green we have the 'real' demand. The continuous line represents sales: since it coincides with the demand, it is covered behind. Therefore, the model shows that given the heuristic policies from the supply chain managers during the year 2002, no shortage to customers was experienced.

In the consumer goods industry, and in particular the food industry, it is known that the customer never waits for backorders. Therefore, the assumption of 2002 demand to test the model is

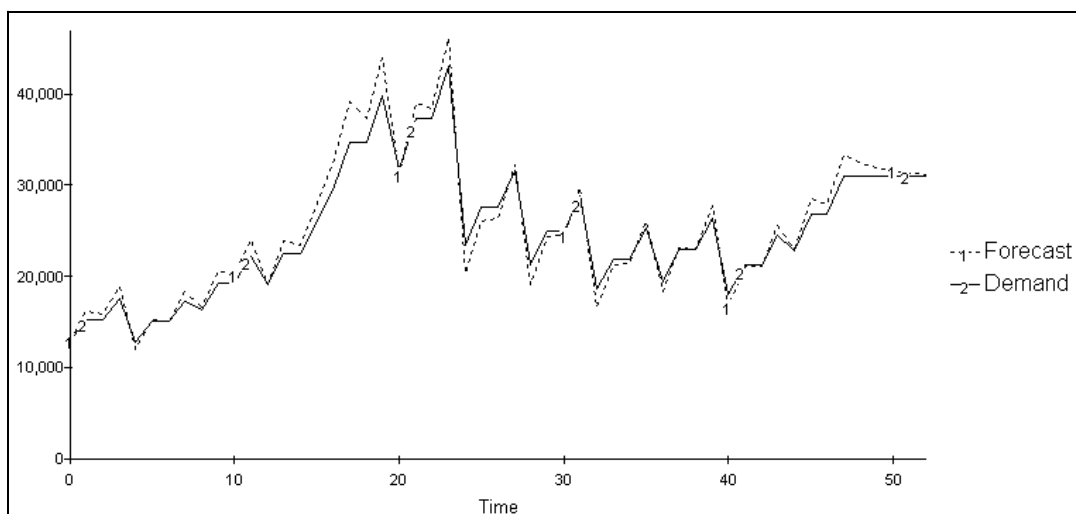

Figure 7: EMSA Customer service and demand forecast

meaningful to provide an interpretation. However, the company only has records about sales and not 'real' demand. Since we use sales as input for the forecast, a bias can be introduced. It can happen that a low forecast causes lost sales resulting in a difference between sales and 'real' demand. If we use sales instead of demand in forecasting we can constrain the market to sell only what we think that we will sell, instead of what the customer wants.

If we analyze the inventories graph, figure 8, we can observe that high inventories are held, and therefore a cost of inventories derived from the heuristic policies from the supply chain managers.

In figure 8 we can also see high raw material stock positions in comparison with the finished goods inventories. This can be caused because: first, the delivery time is more than one week; and second because the coverage policy is one week. These factors together can cause oscillations like the ones shown in the graph, since when the purchase manager decides not to ask for materials, we reach the safety stock limits and a big order is placed leading to excess inventory.

Also, in figure 8, since the stocks have a noisy initial value we can see that it takes around 10 weeks to dissipate, and then the 'real' behaviour of the system appears.

According to the current heuristic policies, inventories follow a similar behaviour to the one described by the demand signal. Due to the

inventory policies, the safety stock is defined as days of coverage times the forecast. Inventories peak between weeks 15 and 25 which coincides with the summer. Notice that inventories are approximately half of demand. This is because the coverage policy is 3 days of demand.

Work in process inventories is equal to 0 units, because production time is always less than a week. Therefore, nothing is in process at the end of every week.

From figure 8 it is possible to see that finished goods inventories at the RDCs move before the finished goods at the DCs. In fact, with one week of phase lag. This phase lag is not caused by the delivering time, which is less than a week, but by the demand which is first served from the RDC before the RDC manager sends an order to the DCs.

We can also see in figure 8 that we do not have any negative stock. Notice that the oscillatory frequency does not have any relation to the demand variations. Demand is clearly seasonal during the year, with peaks during the summer between weeks 15 and 25. This oscillatory distortion is explained next.

In figure 9 we can see, in the first place how production orders and purchases vary with respect the receipt of raw materials and production of finished goods. Purchase and production variability are caused by the time delay and/or the lack of raw material to produce.

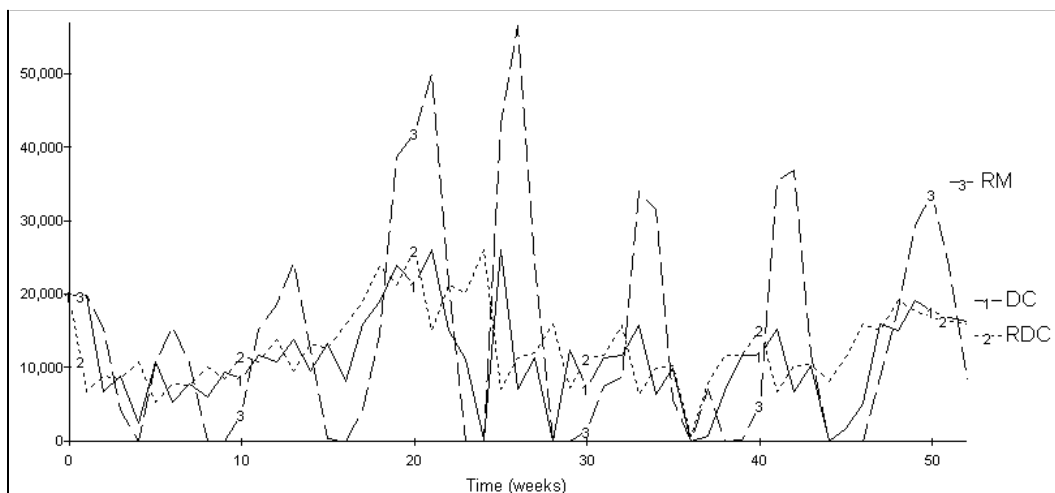

Figure 8: EMSA DC, RDC and RM Inventories

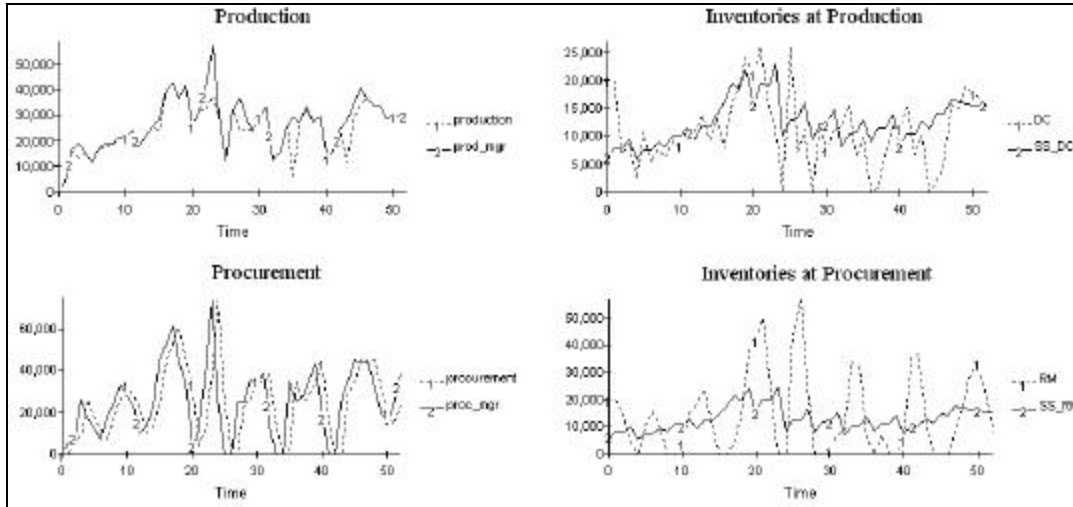

Figure 9: EMSA Production and procurement plans and execution

In figure 9, in relation to production orders, we can see a perfect execution of production orders with the exception of week 45. Due to a shortage of raw material, it is not possible to produce the full requirement coming from the production manager. This raw material shortage produces a reduction of finished goods inventories to almost 0 in the same week. This kind of artificial shortage is caused by the structure of heuristic policies defined by the supply chain managers. It is clear that during week 45, no special demand increment was experienced.

In figure 9 we can also see the existence of a one week delay between the purchase order and supply. The Purchase manager uses his stock position and forecast to order. Given the time delay and the time horizon, he produces oscillations in purchase

orders, and consequently oscillations in inventories even when the safety stock is constant. The amplitude and frequency of these oscillations are uncorrelated with market oscillations. Such uncorrelated oscillations can produce some stock positions near zero, and in particular for the 45th week produce a shortage in production, which affects the DC and RDC inventories, and it is close to impacting on customer service.

Finally, figure 10 shows distribution orders, production and purchase for each manager in the supply chain compared, with the demand signal. From the graph we can see that demand oscillations are less than distribution, production and purchase oscillations respectively. We see the increased distortion of oscillation manifest the Bullwhip Effect, as described by Forrester (1962).

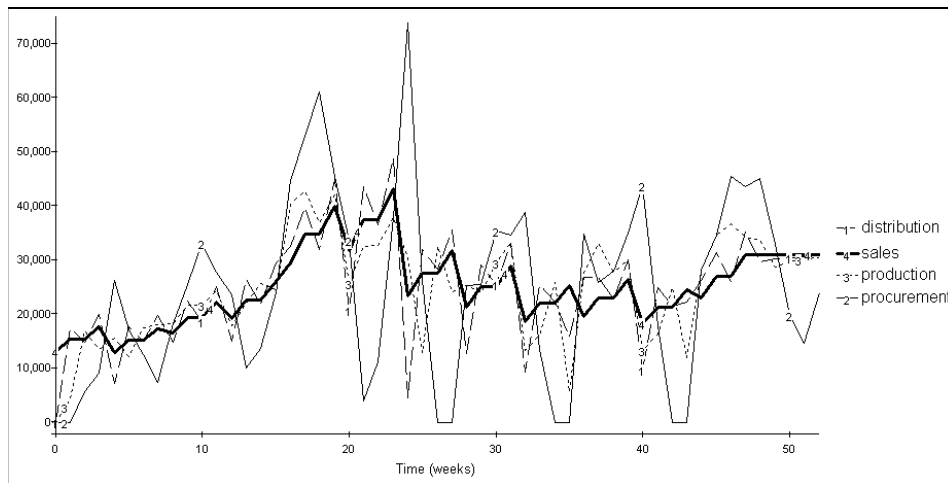

Figure 10: EMSA Bull whip effect

Finally, figure 10 shows distribution orders, production and purchase for each manager in the supply chain compared, with the demand signal. From the graph we can see that demand oscillations are less than distribution, production and purchase oscillations respectively. We see the increased distortion of oscillation manifest the Bullwhip Effect, as described by Forrester (1962).

The bullwhip effect can drive wrong decisions when the production or transport capacity is defined. In our model we can see that the warehouse for raw materials needs a capacity of 90,000 units, and even more than that for finished goods. This warehouse capacity not only represents a fixed asset cost but also an inventory cost due to the financial investment. Consider also that the suppliers can receive orders that vary from 80,000 to zero units from one month to the next.

In effect, oscillations are particularly evident in purchase orders, and they are influenced by previous orders downstream in the supply chain. Notice for instance that during the 25th week, demand is low just after the summer season, which is amplified by distribution and production. But during that same week, the purchase manager receives more than 80,000 units due to a purchase order launched during the middle of the summer.

The bullwhip effect is attributed mainly to two causes: first, the underestimation of time delays between orders and their fulfillment, second, to the existence of a motivation among supply chain managers to request more materials than needed. Better coordination of the supply chain by managers can be promoted once managers are conscious of the global effects of their heuristic policies in the system.

It is intuitive to think that a production, distribution or purchase manager will prefer stability rather than variability. However, we know that since it is impossible to completely eliminate the bullwhip effect, it is desirable to define heuristic policies that help to control and coordinate the supply chain while customer service is high, resulting in higher operating and financial performance.

### *Business case discussion*

A model that represents the policies of supply chain managers can be used as a 'laboratory' where policy changes can be tested towards a better supply chain performance, according to pre-defined corporate goals. We prepared for Pepsi-EMSA some initial scenario analysis that included policy changes for the Pepsi 600 ml product. Scenarios included changes in forecast policies and purchase orders. We will illustrate just what kind of scenarios could be developed for a more detailed study, and how to assess the impact of new policies.

### *Changes in purchase orders*

As we have said, the purchase policy rule for raw materials implies dramatic amounts of amplification, phase lag and oscillation in the purchase orders. We should expect that a better purchase policy exists in order to minimize order and raw material inventories. Suppose that we implement a purchase policy for four seasons, that is, for each season we will define a constant volume of weekly purchases.

Figure 11 shows the values that raw material inventories can take if a seasonal purchase policy is adopted. We shall say that the maximum demand is for 60,000 units, that is, 20,000 units less than the previous policy, with the advantage of stability for the supplier.

A possible problem to define such a seasonal policy is the uncertainty. This seasonal policy behaves relatively well for the historic demand of the year 2002, but due to its rigidity, the same performance for the following years is not expected.

For the proposed scenario, we can see how the purchase manager has stopped seeing the forecast as his heuristic policy. However, notice that the raw material inventory variation does not have any relationship with the demand variation. In general, the existence of a trade off balance between orders and inventory variability is expected. An optimal policy will manage an equilibrium point where the variation of order quantities will be economical and equivalent to variations in inventories.

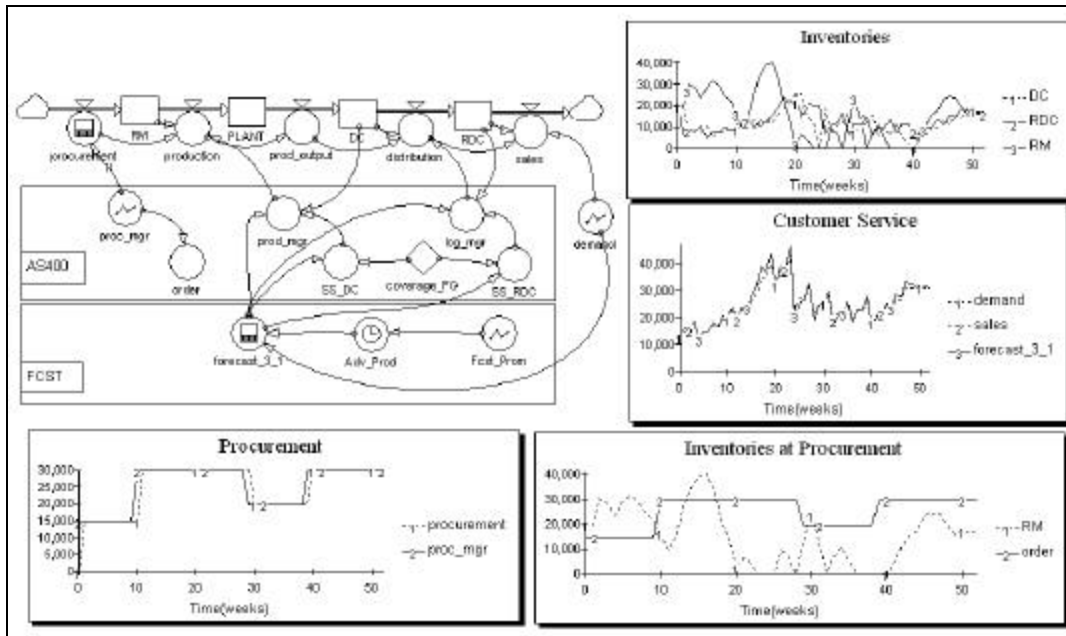

Figure 11: EMSA, Scenario 1

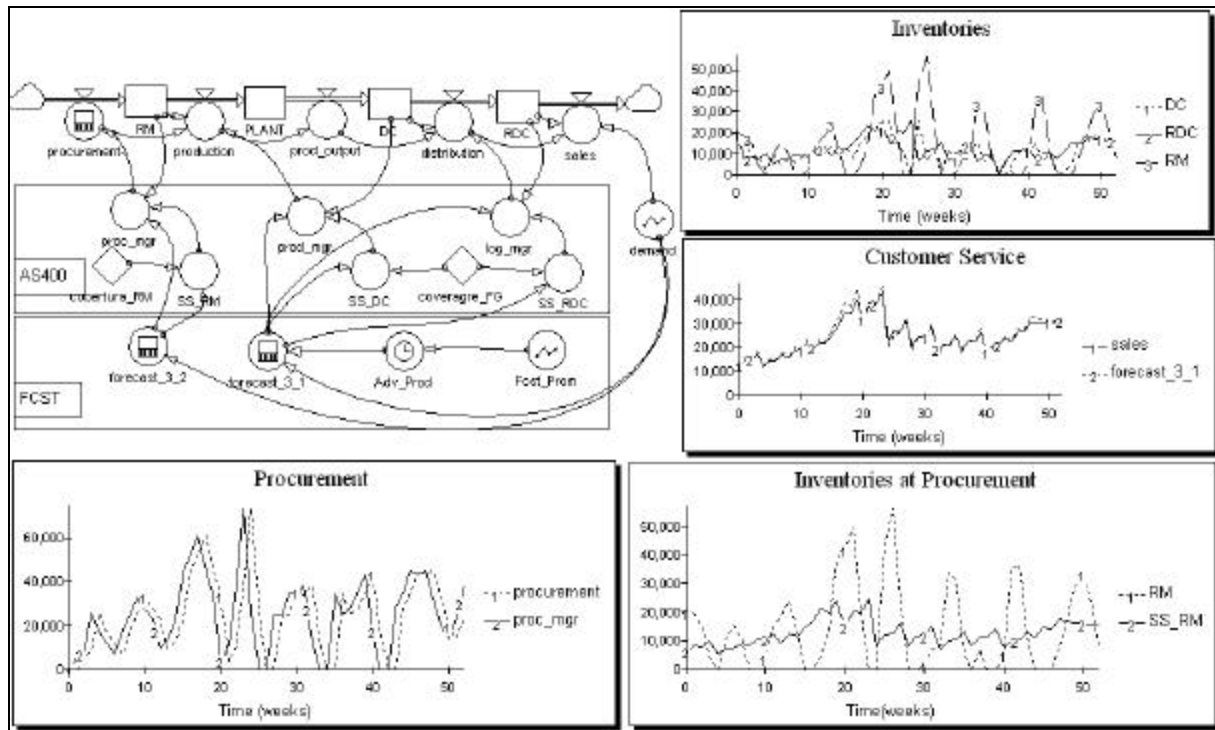

Figure 12: EMSA, Scenario 2

*Changes in forecast*

Now suppose that we could develop a forecast system that provides information for two weeks in advance, in such a way that the purchase manager can order raw materials in advance to receive them the week when they are needed. Because of this new forecast system

he decides to reduce the coverage from 1 week to 0.5 weeks to get together with the rest of the managers.

Figure 12 shows the impact of this new policy. We notice that the maximum inventory of raw materials is now approximately 50,000 units, while the customer service is kept in good health.

Oscillation of the purchase orders are not eliminated, varying from 0 to 70,000 units inside a given season. Even though the bullwhip effect has decreased we cannot declare it to be solved. The inventory costs are still high and the inventory oscillations due to the raw material oscillations cause stresses in different echelons. The oscillation frequency is considerably high.

Under this scenario we have reduced the delivery time from suppliers to one week. Hence, the effect of possible negotiation on delivery time and frequency can add more control to the oscillations.

### Conclusions and further research

In this paper it was not our intention to develop a technique to define the best policies, nor the best way to define new policies in order to improve supply chain behaviour. Our intention was to define a model where the main dynamics causing Bullwhip Effect may be studied in order to comprehend the cause-effect relationships between policies, information flows and decision rules of a given supply chain. We have shown that is possible to build such a model and to capture with relative simplicity but high degree of abstraction the complexities of a Supply Chain.

However, due to its simplicity, the model is limited in different ways. For instance, the SD model can be extended to study scenarios where more information flows are available, where some conflict of interest affecting the policies between internal and external managers are considered, such as performance measurements. Also the model may be used to study the particularities of different industries and establish comparisons across industries, to study the influences of different forecast methods as well as consensus meetings, etc. Consequently, in this paper, and for the sake of brevity we have only focused in describe a business case where a SD model was created to illustrate and analyse a particular situation, but not to solve the Bullwhip Effect. What is intended on this paper is to emphasize methodology used to examine a particular problem, especially because in our opinion, and we coincide with many other authors, the Bullwhip Effect is a problem concerned with the information flow and policy alignment.

With models like the one presented here it is possible to study and compare different companies and different sectors by using experimental input signals, and supply chain performance measures taken from either operations management or from control theory. Unfortunately, the space here is short to describe those methods in detail but useful references may be found in Villegas (2005).

Finally, it is important to say that even when the model's calibration process has not been described in detail in this paper it is in general possible to calibrate a model of this complexity to match many data samples. What is important of SD models, as it has been stated in the field, is that they represent the main cause-effect dynamics that generate a given system's behaviour. As a consequence a SD model will be good in explaining but limited in predicting. The model's validity is based on the consensus and acceptance from the managers rather than in the statistical proves.

### Acknowledgments

We would like to thank the anonymous referees for their helpful suggestions that have allowed us to improve the exposition of this research

### References

- Dejonckheere J., Disney S.M., Lambrecht M.R. and Towill D.R. (2002). Transfer Function Analysis of Forecasting Induced Bullwhip in Supply Chains. *International Journal of Production Economics*, 78, pp.133-144.
- Dejonckheere J., Disney S.M., Lambrecht M.R. and Towill D.R. (2003). Measuring and Avoiding the Bullwhip Effect: A Control Theoretic Approach. *European Journal of Operational Research*, 147, 3, pp.567-590.
- Dejonckheere J., Disney S.M., Lambrecht M.R. and Towill D.R. (2004). The Impact of Information Enrichment in the Bullwhip Effect in Supply Chains: A Control Engineering Perspective. *European Journal of Operational Research*, 153, 3, pp.727-750
- Doyle J.K. and Ford, D.N. (1998). Mental Models Concepts for System Dynamics Research. *System Dynamics Review*, 14, 1, pp. 3-29.

- Forrester J.W. (1962). *Industrial Dynamics*. USA: The MIT Press.
- Naim N.M., Childerhouse O., Disney S.M. and Towill D.R. (2002). A Supply Chain Diagnostic Methodology: Determining the Vector of Change. *Computers & Industrial Engineering*, 43, pp.135-157.
- Lee H., Padmanabhan V. and Whang S. (1997a). Information Distortion in a Supply Chain: The Bullwhip Effect. *Management Sciences* 43, 4, pp.546-558.
- Lee H., Padmanabhan V. and Whang S. (1997b). The Bullwhip Effect in Supply Chains. *Sloan Management Review*, Spring, pp.93-102.
- Lane D.C. (2001). Rerum Cognoscere Causas: How do the Ideas of System Dynamics Relate to Traditional Social Theories and the Voluntarism/determinism Debate? *System Dynamics Review*, 17, 2, pp. 97-118.
- Sterman J. (1989). Modelling Managerial Behaviour: Misperceptions of Feedback in Dynamic Decisions Making Experiment. *Management Science*, 35, 3, pp. 321-339.
- Sterman J. (2000). *Business Dynamics*. USA: MacGraw-Hill.
- Sterman J. (2002). All Models are Wrong, Reflections on Becoming a Systems Scientist. *Systems Dynamics Review*, 18, 4, pp. 501-531.
- Towill D.R., Wikner J.J. and Naim M. (1991). Smoothing Supply Chain Dynamics. *International Journal of Production Economics*, 22, pp.231-248.
- Towill D.R. (1995). Industrial Dynamics Modelling of Supply Chains. *International Journal of Physical Distribution Logistics Management*, 26, 2, pp.23-42.
- Villegas F. (2005). Supply Chain Dynamics, Structural Causes of the Bullwhip Effect. *Working Paper*, Manchester Business School, University of Manchester.

---

### Semblanza de los autores

*Felipe A. Villegas-Morán*. Labora en el Departamento de Dirección de Operaciones en la Manchester Business School, University of Manchester en el proyecto de "Supply Chain Dynamics". Es investigador en The School of Management, University of Edinburgh en el proyecto de "Transfer Prices in Multinational Supply Chains". Su investigación doctoral es sobre la implantación de sistemas de información en cadenas de suministro en la Facultad de Ingeniería de la UNAM.

*Octavio Carranza*. Obtuvo el Premio Nacional de Logística 2005, labora en el Departamento de Logística y Distribución en la Escuela de Ciencias Contables Económico Administrativas, Universidad Panamericana, México. Es doctor en dirección de operaciones por la Universidad de Navarra, España y autor del libro "Mejores prácticas logísticas".

*Juan P. Antún*. Obtuvo el Premio Nacional de Logística 2005. Actualmente es investigador y profesor titular del seminario de investigación en logística empresarial MIT/DEPFI/UNAM, en el Laboratorio de Transporte y Sistemas Territoriales de la Coordinación de Ingeniería de Sistemas del Instituto de Ingeniería, UNAM. Asimismo, es consultor en logística estratégica e internacional, profesor de logística internacional MAE/ITAM e instructor externo del Instituto de Desarrollo Exportador BANCOMEXT.